

DISCOVERY II AC Series Installation Guide

Thanks for choosing our Discovery II AC Series ceiling fan.

We strongly recommend that you read this manual carefully before installation.



Models Parameters (Fan Only):-

MDF124W	1220mm 4 Blade Ceiling Fan White Satin
MDF124M	1220mm 4 Blade Ceiling Fan Matt Black
MDF134W	1320mm 4 Blade Ceiling Fan White Satin
MDF134M	1320mm 4 Blade Ceiling Fan Matt Black
MDF144W	1420mm 4 Blade Ceiling Fan White Satin
MDF144M	1420mm 4 Blade Ceiling Fan Matt Black

Models Parameters (Fan and LED Light):-

MDF1243W	1220mm 4 Blade Ceiling Fan White Satin with 15w LED Light
MDF1243M	1220mm 4 Blade Ceiling Fan Matt Black with 15w LED Light
MDF1343W	1320mm 4 Blade Ceiling Fan White Satin with 15w LED Light
MDF1343M	1320mm 4 Blade Ceiling Fan Matt Black with 15w LED Light
MDF1443W	1420mm 4 Blade Ceiling Fan White Satin with 15w LED Light
MDF1443M	1420mm 4 Blade Ceiling Fan Matt Black with 15w LED Light

Part List:

Qty 1x motor assembly	Qty 1x instruction manual	Qty 1x screw kit	Qty 1x balancing kit
Qty 1x hanging bracket	Qty 1x wall control kit	Qty 4x blades	

Application

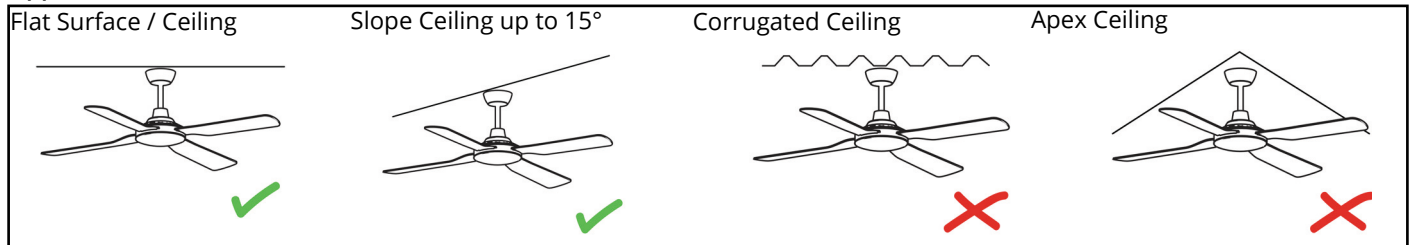

How to Assemble

<p>Fg.1</p> <p>Secure the hanger bracket to ceiling beam or a suitable piece of timber inserted between the ceiling beams using the two long screws supplied with the package.</p>	<p>Fg.2</p> <p>Place circular shockproof gasket above the hanger bracket. Align the bracket and screw the hanger bracket to the ceiling tightly.</p>	<p>Fg.3</p> <p>Place fan into hanger bracket and align Ball Joint Slot with hanger bracket as illustrated.</p>	<p>Fg.4</p> <p>After wiring is completed, attach the canopy to the hanger bracket by pushing upwards and twisting anti-clockwise. Tighten screws and ensure canopy is not touching the ball joint.</p>
---	---	---	---

WARNING Installation MUST carry out by a qualified and licensed electrician.

How to Install Blades

Fig.5

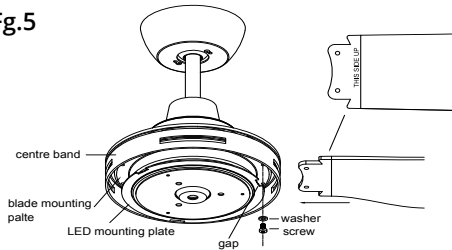

The side of the blade marks with "THIS SIDE UP" should be facing upward.

1. Align holes on the blades with holes at the bottom of the motor.
2. Insert the blade and secure with screw.
3. Repeat the same step until all blades are installed.

NB: Ensure the blades do not get damaged or bent during the installation process while the fan maybe on the ground, this will affect the performance and balance of the fan and this is NOT covered under warranty.

How to Install Light Plate

Fig.6

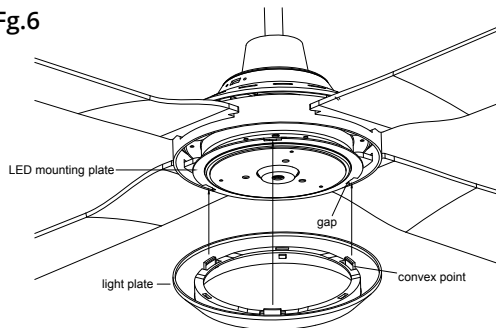

Align the convex point on the light plate with the gap on the LED mounting plate and press down firmly.

CCT (Colour Changeable Temperature)

Fig.7

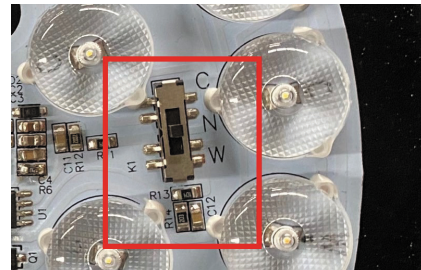

Choose colour temperature by flicking the switch in the LED
C = 5000K cool white
N = 4000K neutral white
W = 3000K warm white

How to Install / Remove the Cover

Fig.8 Fan only model

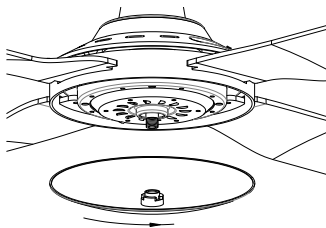

Place the cover plate and screw the tooth hole of the cover plate to the motor shaft.

Fig.9 Fan LED Light Model

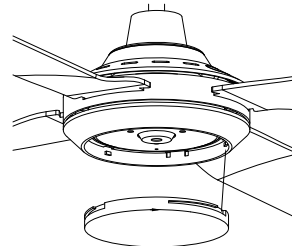

Turn anti-clockwise to remove and clockwise to tighten.

WARNING Installation **MUST** carry out by a qualified and licensed electrician.

Dimming

The Discovery II ceiling fan has a smart 3 step dimming LED light module which doesn't require a dimmable remote control or a wall dimmer. It only requires a normal on/off remote kit (MPREMS) or a normal light wall switch. (Supplied in remote control kit).

Turn the switch on and the light will turn on. Flick the switch on/off within 1 second and the light output will dim down to approx. 50%. Flick the switch on/off again and the light output will dim down to approximately 15%. The light kit has no memory function, It will turn on 100% initially.

Installing Receiver Remote Control

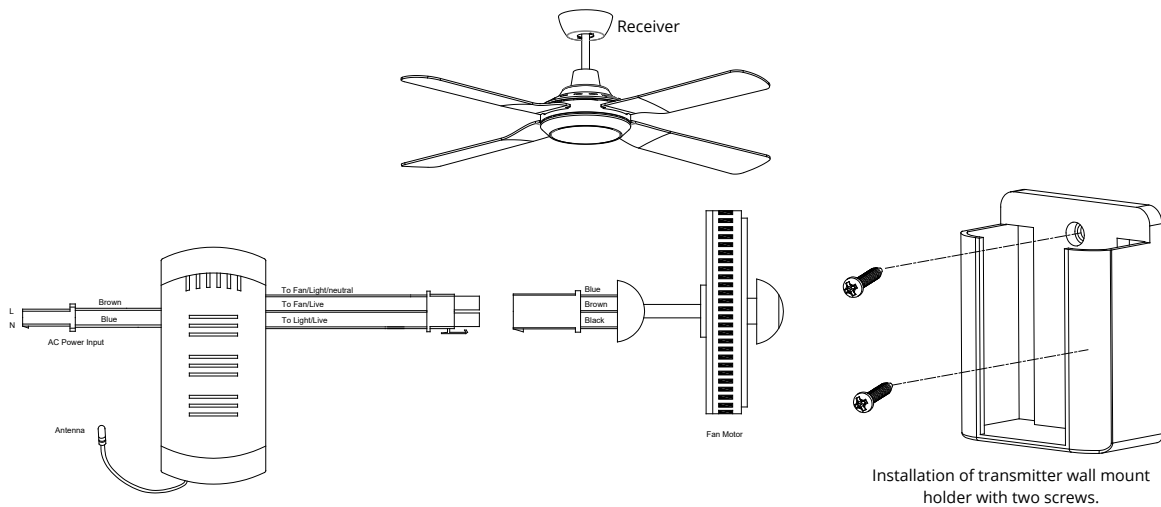

Setting the code on transmitter

1. Remove battery cover
2. Slide code switches to your choice of ON/OFF position
3. Install battery (supplied)

Setting code on receiver:-

1. Slide code switches on the receiver in the same position set on the transmitter

Optional Accessories

Martec® remote control for AC Ceiling Fan illustrated below are sold separately.



MPREMS
Premier Remote Control



MPLCDS
Premium LCD Remote Control



MWFBT
Smart Remote Control

WARNING Installation MUST carry out by a qualified and licensed electrician.

Wire Connections

NB: Wall control Fan Only

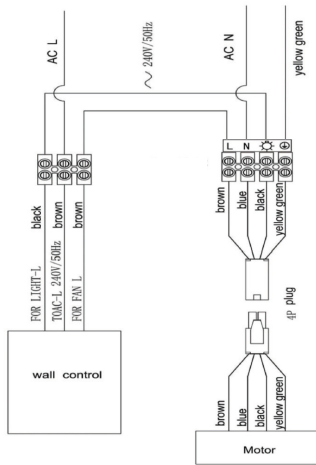

NB: Wall control Fan LED Light

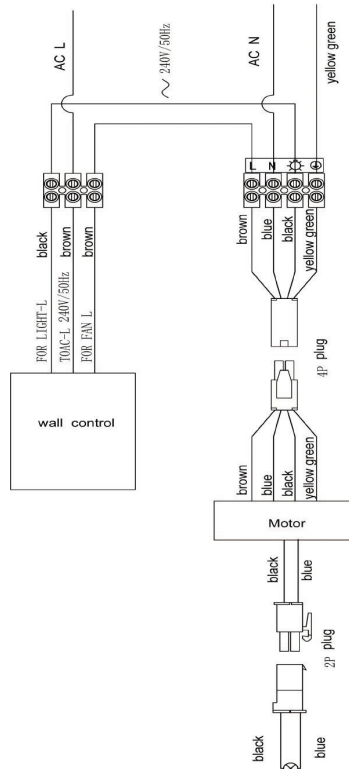

NB: Remote Control Fan Only and Fan LED Light

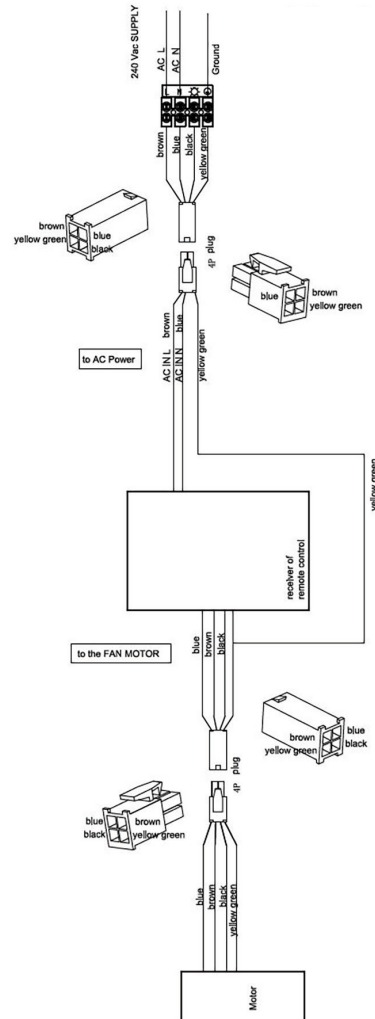

6* Year Warranty

Visit our website for details <https://www.martecaustralia.com.au/warranty-statement/>



WARNING

- Installation of fans **MUST** follow SAA standards and meet local authority regulations.
- Installation **MUST** be carried out by a qualified and licensed electrician.
- Fan and light **MUST** be earthed.
- Bracket **MUST** be firmly attached to a flat solid structure or timber frame.
- **DO NOT** mix blades from one model to another, all blades **MUST** be replaced if damaged.
- The warranty is **VOID** if product is not installed according to this installation guide.